

RECEIVED on 04/08/2026 CDLP26-02007
 By Contra Costa County
 Department of Conservation and Development

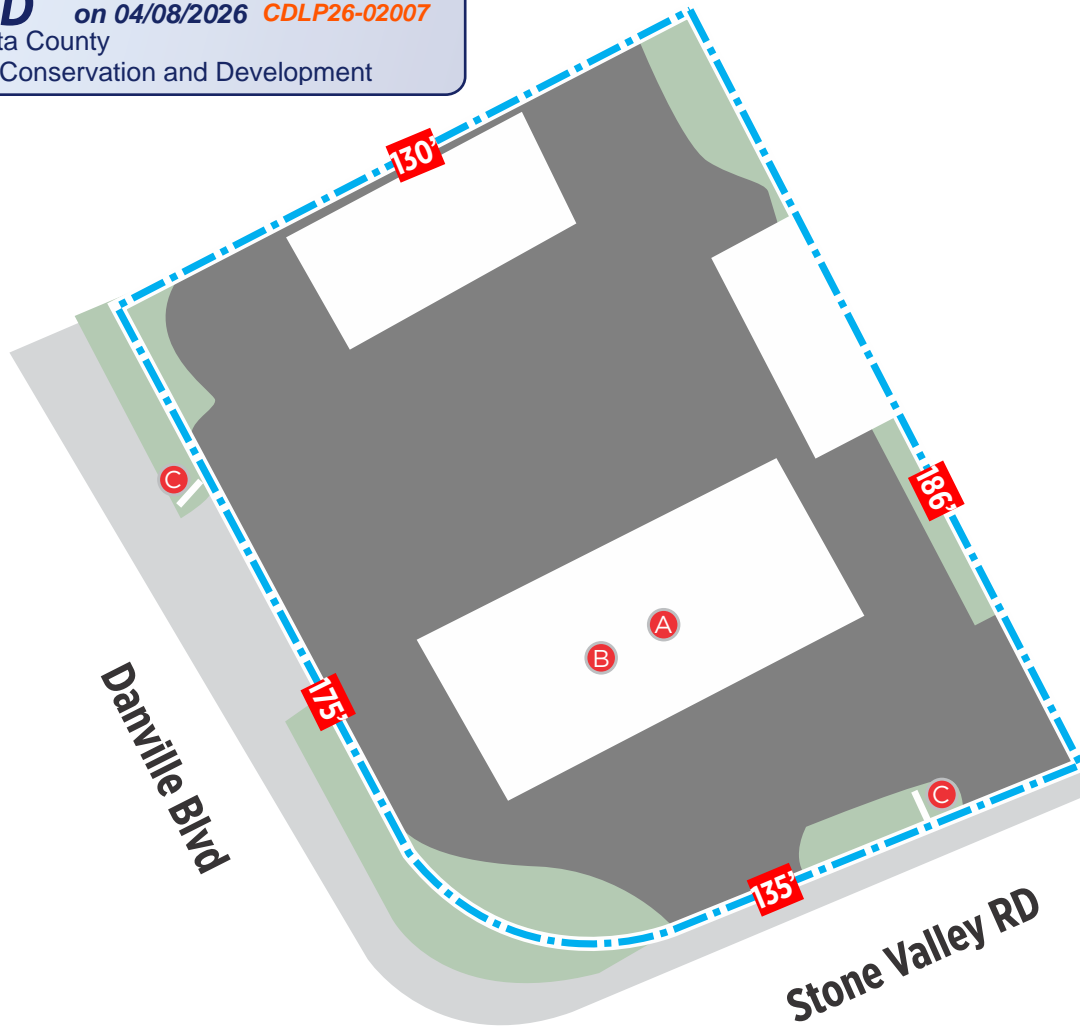

Vicinity Map

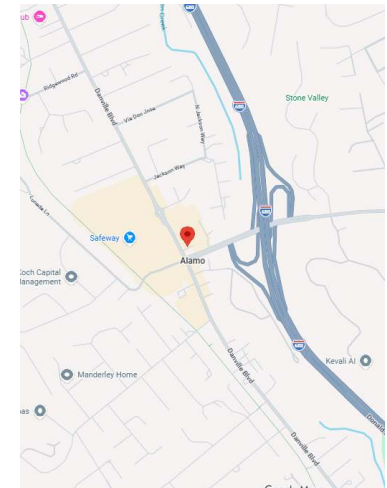

Siteplan Legend

- A** Canopy
- B** Under Canopy
- C** MID

NOTE: All "Rebel Wash" bollard signs are not allowed and will need to be removed.

APN: 192-081-003-1



PROMOTION PLUS SIGN CO., INC.
 "The Imaging Experts"

Check Us Out On zoomsupply.com

21034 Osborne St. (P) 818.993.5406
 Canoga Park, CA 91304 (F) 818.993.3174

State License: 853228



Job Location

Site:379
 3188 Danville Boulevard,
 Alamo, California 94507

Owner Information

Humburg Investments LLC
 C/O Accounts Payable
 1450 N Benson Ave #A
 Upland, CA 91786

Project Information

Project: Shell MVI
 Est: 141963
 Date: 03.06.2026
 Rev: 02
 Designer: RH/SM/PC

Approval

X	X
Owner	Date
I have reviewed all renderings and I am satisfied with the look and the scope of work listed within.	
This rendering is property of Promotion Plus Sign Co., Inc. and cannot be reproduced without written consent of owner	

Permit Pack



PROMOTION PLUS SIGN CO., INC.
 "The Imaging Experts"

Check Us Out On zoomnsupply.com

21034 Osborne St. (P) 818.993.5406
 Canoga Park, CA 91304 (F) 818.993.3174

State License: 853228



Job Location

Site:379
 3188 Danville Boulevard,
 Alamo, California 94507

Owner Information

Humburg Investments LLC
 C/O Accounts Payable
 1450 N Benson Ave #A
 Upland, CA 91786

Project Information

Project: Shell MVI
 Est: 141963
 Date: 03.06.2026
 Rev: 02
 Designer: RH/SM/PC

Approval

X	X
Owner	Date
I have reviewed all renderings and I am satisfied with the look and the scope of work listed within.	

This rendering is property of Promotion Plus Sign Co., Inc. and cannot be reproduced without written consent of owner

Permit Pack

A Canopy

L Canopy Length: 88'-08"

W Canopy Width: 39'-08"

Fascia Height: 30 1/8" (Extended to 36")

Clearance: 13'-6"

A South Elevation | Illuminated Logo

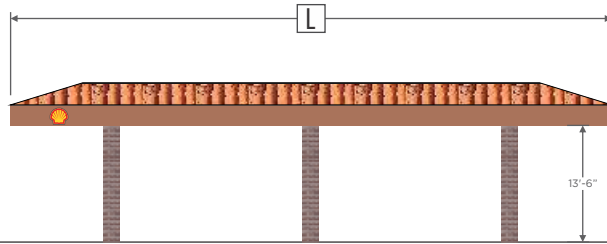

A West Elevation | Illuminated Logo

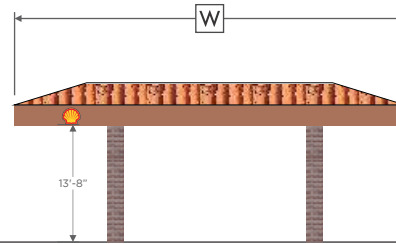

A North Elevation | Non-Illuminated

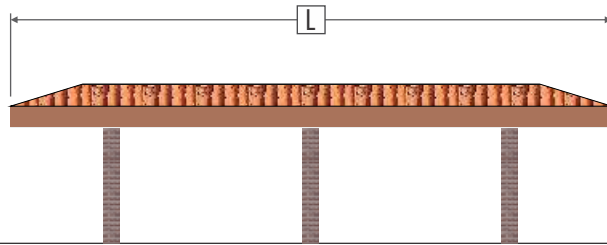

A East Elevation | Non-Illuminated

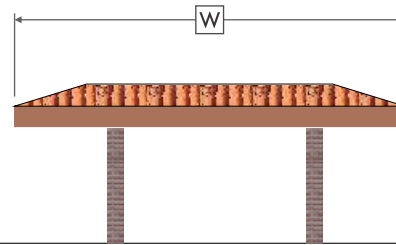

1:200

Canopy Notes

- 2 Illuminated logos (S&W elevation)
- Powerwash Canopy
- Upgrade Lights If Needed

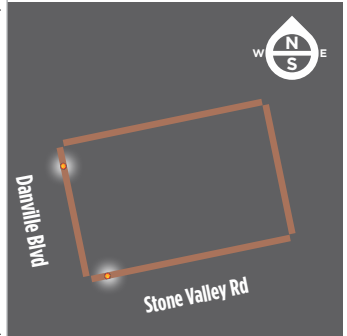

Shell Vacuum Formed Pecten | x2 | 5.44 sqft ea.

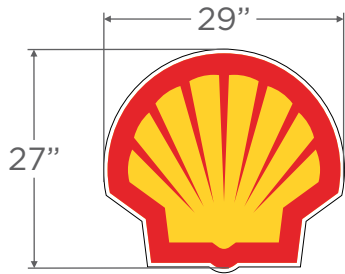

Clearance Sign | Qty 2 per Side



Clearance 13'-6"

2.083 sqft ea.

LED MODULE:



AA LED - 50W (Ip67) 12V Unit

WEATHER SEALED CONDUIT TO CONNECT TO EXISTING ELECTRICAL

.040 ALUM. RETURNS AND BACK

3/16" VACUUM FORMED POLYCARBONATE "PUSH THRU" STYLE LOGO

WHITE LED'S

063 ALUM. BACKING PLATE FOR LED'S

UL APPROVED 2A-120V-50/60Hz REMOTE TRANSFORMER

ON/OFF DISCONNECT SWITCH

ACCESSIBLE ON RIGHT SIDE

DRAIN SLOT

CANOPY FASCIA

Illumination Area



Night view (intensity may vary)

PMS 116c | 3M 3630-015 Yellow | DP Match

PMS 485c | 3M 3630-143 Poppy Red | DP Match



PROMOTION PLUS SIGN CO., INC.
"The Imaging Experts"

Check Us Out On zoomnsupply.com

21034 Osborne St. (P) 818.993.5406
Canoga Park, CA 91304 (F) 818.993.3174

State License: 853228



Job Location

Site:379
3188 Danville Boulevard,
Alamo, California 94507

Owner Information

Humburg Investments LLC
C/O Accounts Payable
1450 N Benson Ave #A
Upland, CA 91786

Project Information

Project: Shell MVI
Est: 141963
Date: 03.06.2026
Rev: 02
Designer: RH/SM/PC

Approval

Owner **Date**
I have reviewed all renderings and I am satisfied with the look and the scope of work listed within.
This rendering is property of Promotion Plus Sign Co., Inc. and cannot be reproduced without written consent of owner

Permit Pack

B Under Canopy

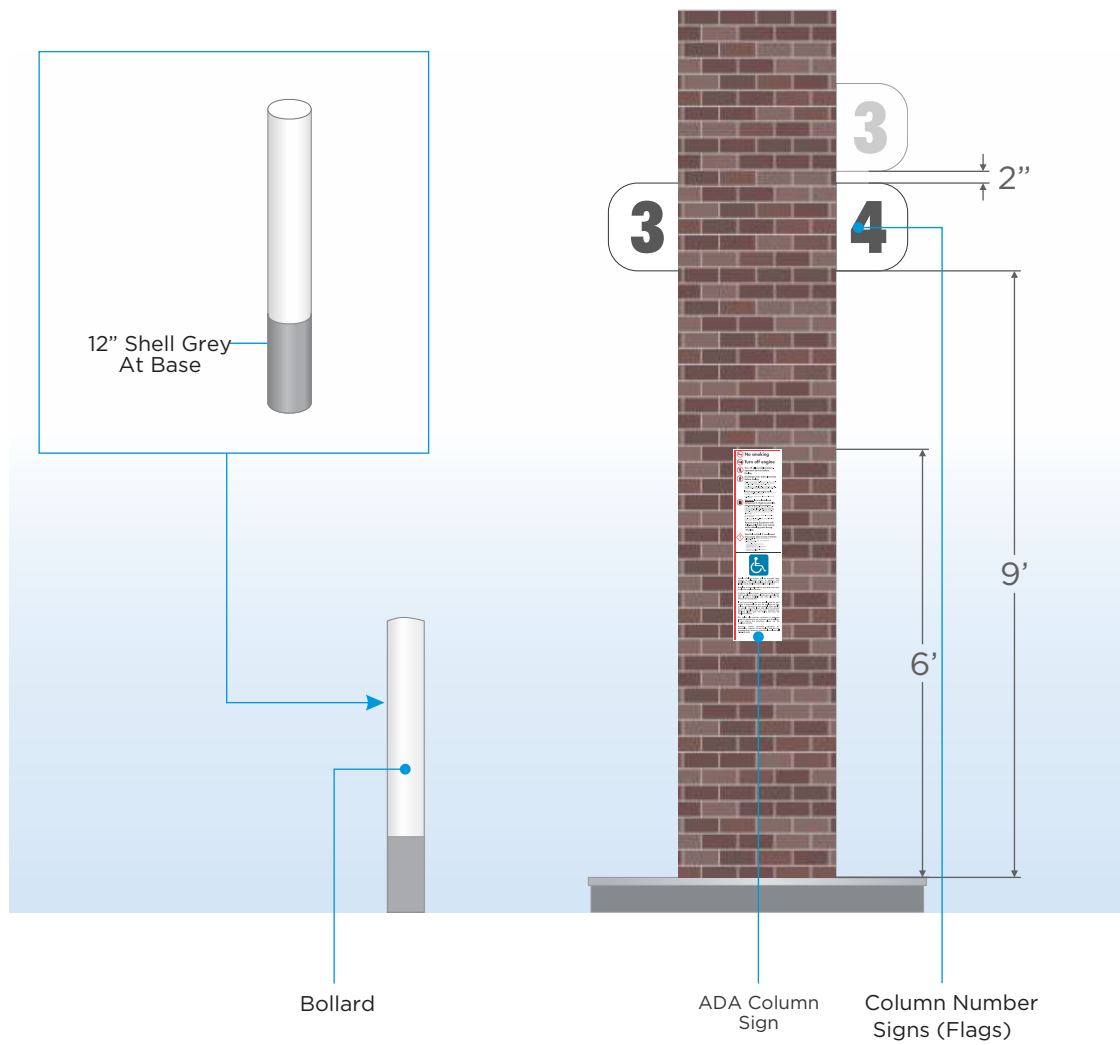

Notes/Disclaimers	
Image to MVI Brand Standards	
Elements See Following Pages For Details	
Disp Flags	Pump Flags Visible From Approach
Bollards	Removal of all bollard signs.
Painting	All Bollards, columns, curbs dispenser kick plates, area lights C-Store.



Job Location
Site:379
3188 Danville Boulevard,
Alamo, California 94507

Owner Information
Humburg Investments LLC
C/O Accounts Payable
1450 N Benson Ave #A
Upland, CA 91786

Project Information
Project: Shell MVI
Est: 141963
Date: 03.06.2026
Rev: 02
Designer: RH/SM/PC

Approval	
X	X
Owner	Date
I have reviewed all renderings and I am satisfied with the look and the scope of work listed within.	
This rendering is property of Promotion Plus Sign Co., Inc. and cannot be reproduced without written consent of owner	

Check Us Out On zoomsupply.com

21034 Osborne St. Canoga Park, CA 91304
State License: 853228

(P) 818.993.5406
(F) 818.993.3174

Permit Pack

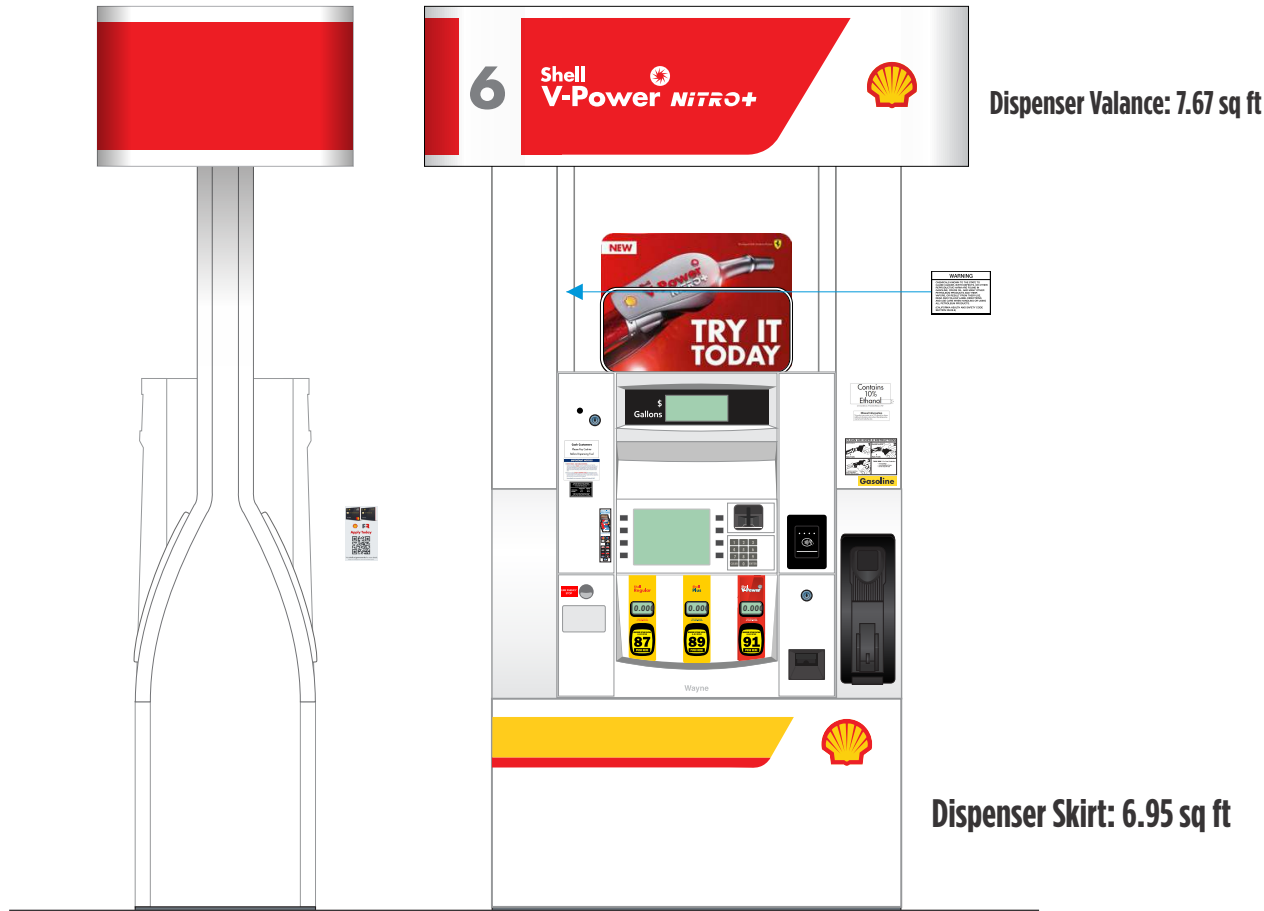

Existing Dispenser



Dispenser

Existing: Wayne Ovation 2
3+0 Dispenser | Qty: x6

Dispenser Elements

- Valance — New Standard Pump Valances 68" x 16"
- Decals —
 - Warning Decal
 - Pump Number
 - Credit Card Decal
 - Crind Overlays
 - Product ID Decals
 - Octane Decals
 - QR Code Decal
 - Warning Decal
 - Ethanol Decal
 - Nozzle Boot & Bezel Overlays
 - Regulatory Decals As Needed
 - Prop 65 Decal (CA Only)
- Skirts — Doorskins
- Toppers — Standard Shell Pump Toppers

Tank Tags

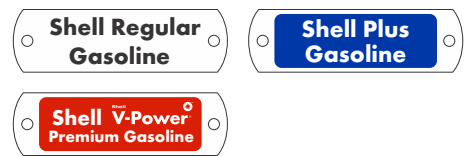

PROMOTION PLUS SIGN CO., INC.
"The Imaging Experts"

Check Us Out On zoomnsupply.com

21034 Osborne St. Canoga Park, CA 91304
(P) 818.993.5406
(F) 818.993.3174

State License: 853228



Job Location

Site:379
3188 Danville Boulevard,
Alamo, California 94507

Owner Information

Humburg Investments LLC
C/O Accounts Payable
1450 N Benson Ave #A
Upland, CA 91786

Project Information

Project: Shell MVI
Est: 141963
Date: 03.06.2026
Rev: 02
Designer: RH/SM/PC

Approval

Owner: _____ Date: _____
I have reviewed all renderings and I am satisfied with the look and the scope of work listed within.

This rendering is property of Promotion Plus Sign Co., Inc. and cannot be reproduced without written consent of owner

Permit Pack

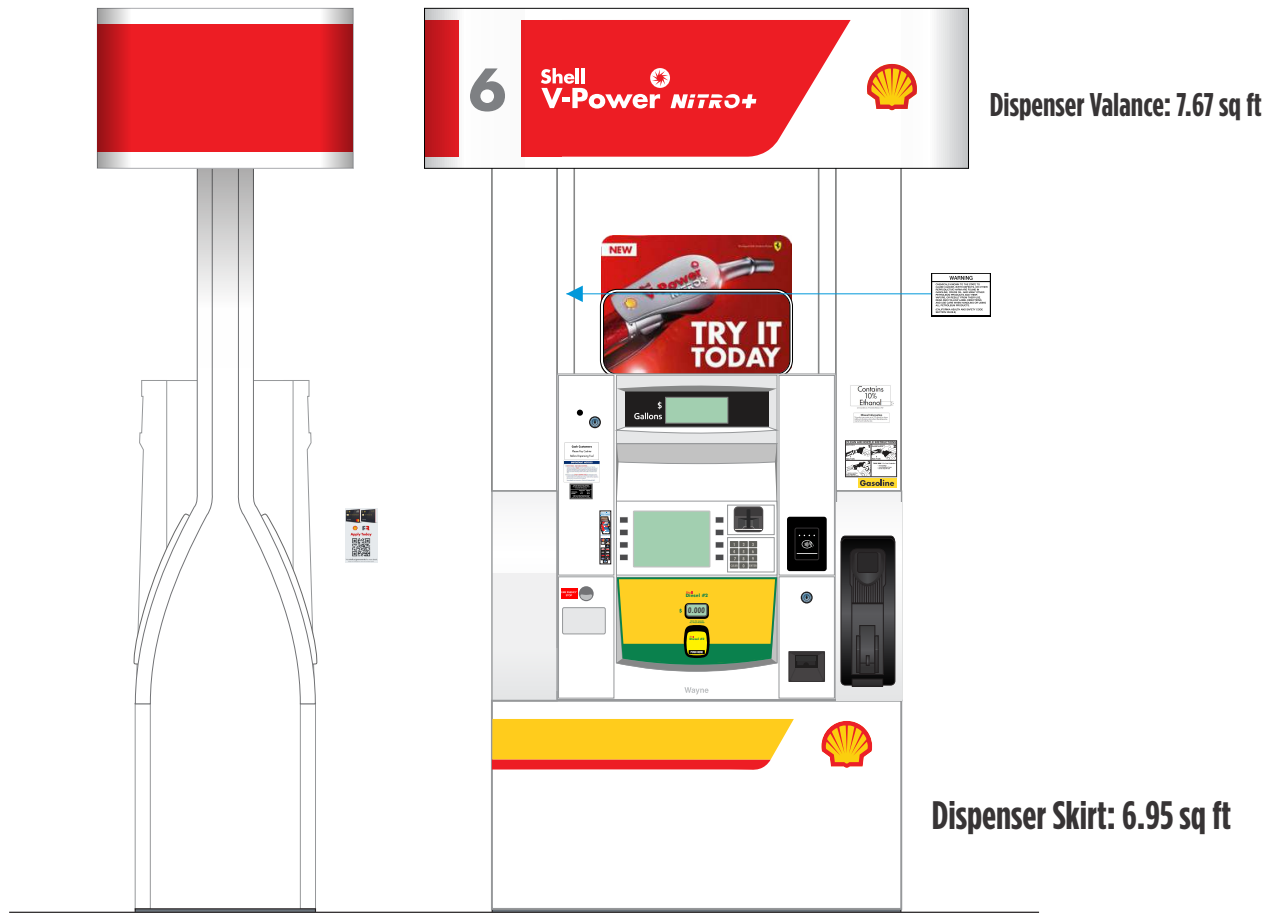

Existing Dispenser



Dispenser

Existing: Wayne Ovation 2
1+0 Dispenser | Qty: x2

Dispenser Elements

- Valance — New Standard Pump Valances 68" x 16"
- Decals —
 - Warning Decal
 - Pump Number
 - Credit Card Decal
 - Crind Overlays
 - Product ID Decals
 - Octane Decals
 - QR Code Decal
 - Warning Decal
 - Ethanol Decal
 - Nozzle Boot & Bezel Overlays
 - Regulatory Decals As Needed
 - Prop 65 Decal (CA Only)
- Skirts — Doorskins
- Toppers — Standard Shell Pump Toppers

Tank Tags



PROMOTION PLUS SIGN CO., INC.
"The Imaging Experts"

Check Us Out On zoomsupply.com

21034 Osborne St. Canoga Park, CA 91304
(P) 818.993.5406
(F) 818.993.3174

State License: 853228



Job Location

Site:379
3188 Danville Boulevard,
Alamo, California 94507

Owner Information

Humburg Investments LLC
C/O Accounts Payable
1450 N Benson Ave #A
Upland, CA 91786

Project Information

Project: Shell MVI
Est: 141963
Date: 03.06.2026
Rev:02
Designer: RH/SM/PC

Approval

Owner: Date:
I have reviewed all renderings and I am satisfied with the look and the scope of work listed within.

This rendering is property of Promotion Plus Sign Co., Inc. and cannot be reproduced without written consent of owner

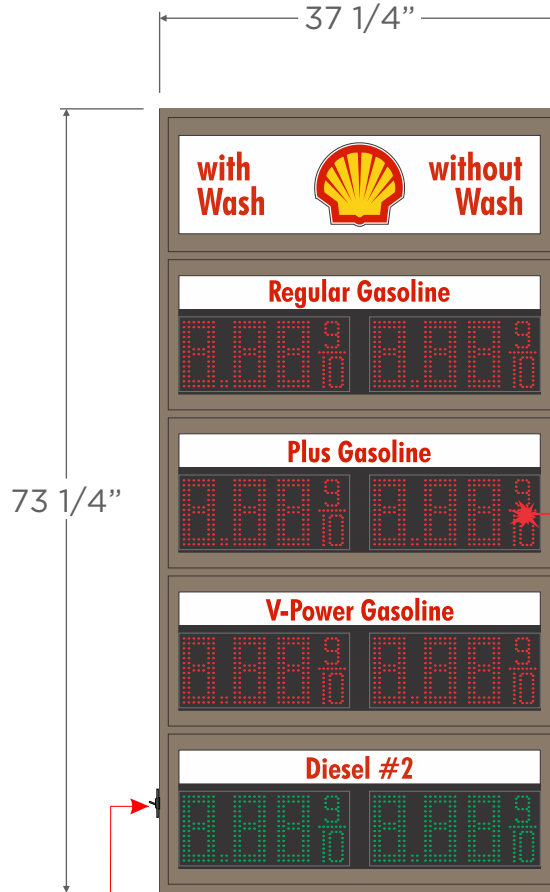
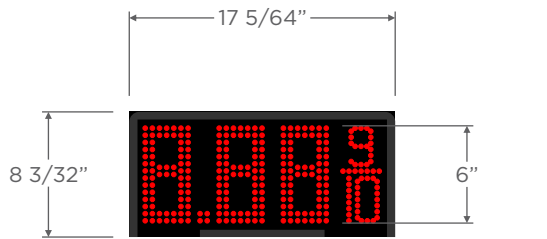
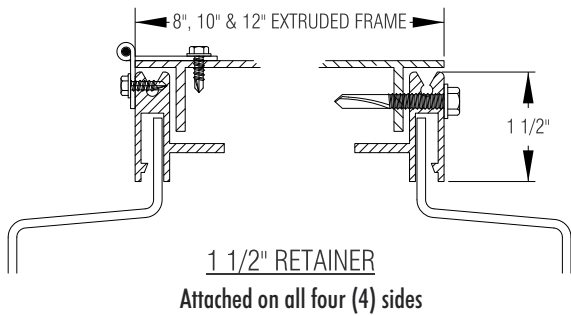

MVI Secondary Price Sign | Double Sided | x2 | 1:18

Internally LED Illuminated Cabinet
Routed-out Aluminum face w/ Plastic windows
2T 8P | 6" ALE LED Digits (Red & Green)

Existing Sign



Night View

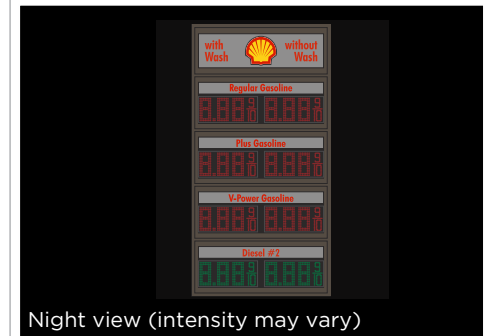

Details

- Faces — Replacement Faces Only
- Logo — Pecten Is Formed Pushthrough
- Painting — Cabinet to be Painted to Shell MVI Standard
- Cabinet — LED Retrofit for Existing Cabinet

PMS 116 C

PMS 485 C

Shell Silver Champagne



PROMOTION PLUS SIGN CO., INC.
"The Imaging Experts"

Check Us Out On zoomnsupply.com

21034 Osborne St. (P) 818.993.5406
Canoga Park, CA 91304 (F) 818.993.3174

State License: 853228



Job Location

Site:379
3188 Danville Boulevard,
Alamo, California 94507

Owner Information

Humburg Investments LLC
C/O Accounts Payable
1450 N Benson Ave #A
Upland, CA 91786

Project Information

Project: Shell MVI
Est: 141963
Date: 03.06.2026
Rev: 02
Designer: RH/SM/PC

Approval

Owner Date
I have reviewed all renderings and I am satisfied with the look and the scope of work listed within.

This rendering is property of Promotion Plus Sign Co., Inc. and cannot be reproduced without written consent of owner

Permit Pack